

# 2023/2024 PRODUCT GUIDE

Woodworking Tools and Machinery



**CARBATEC.CO.NZ**

North Island: 0800 444 329 or  
09 274 9454

South Island: 03 242 0606

**carbatec**<sup>®</sup>  
THE HOME OF WOODWORKING



**ZETSAW**  
Japanese Crosscut Carpenters Saw - 300 mm

Part No. **Z-15011**

Blade for Z-15011 Japanese Universal Saw

Part No. **Z-15012** (Fine)

Blade for Z-15011 Japanese Carpenter's Rip Saw

Part No. **Z-15013** (Coarse)



**ZETSAW**  
Japanese Crosscut Carpenters Saw - 250 mm

Part No. **Z-15006**

Blade for Z-15006 Japanese Universal Saw H-250

Part No. **Z-15007** (Fine)



**ZETSAW**  
Japanese Fine Tooth Joinery Saw - 240 mm

Part No. **Z-7029**

Blade for Z-7029 Japanese Fine Tooth Joinery Saw

Part No. **Z-7030**

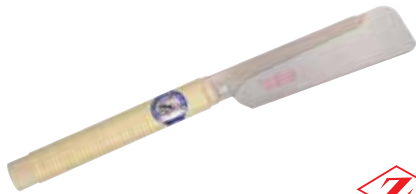

**ZETSAW**  
Japanese General Purpose Saw - 150 mm

Part No. **Z-7010**

Blade for Z-7010 Japanese General Purpose Saw

Part No. **Z-7011**



**ZETSAW**  
Japanese Double-Sided Flush Cutting Saw

Part No. **Z-1500**

Double-Sided Flush Cutting Replacement Blade:

Part No. **Z-1510**



**ZETSAW**  
Japanese Single-Sided Flush Cutting Saw

Part No. **Z-150S**

Single Sided Flush Cutting Replacement Blade:

Part No. **Z-151S**



**PAX SAWS**  
Veneer Saw

Part No. **PAX-VS**



**PAX SAWS**  
8" Gents Saw

Part No. **PAX-G8**



**PAX SAWS**  
22" Handsaw

Part No. **PAX-22**



**PEGAS**  
HD Coping Saw

Part No. **PEG-49-711**



**OLSON**  
Jewellers Saw Frame

Part No. **OLS-JS-63525**



**PAX SAWS**  
12" Tenon Saw

Part No. **PAX-T12**



**TOPMAN**  
**Square Head Hammer - 115 g**  
 Part No. **JH-115**  
 Also available in 225 g  
 Part No. **JH-225**



**CARBATEC**  
**Wooden Carpenter's Mallet - 113 mm**  
 Part No. **CT-260420**



**VERITAS**  
**Cabinetmakers Mallet**  
 Part No. **05E15-01**



**CARBATEC**  
**Deadblow Hammer - 500 g**  
 Part No. **PU-038**  
 Also available in 920 g - Part No. **PU-050**



**GROZ**  
**Nail Punch - Set of 3**  
 Part No. **GZ-25366**



**NEW!**  
**VERITAS**  
**Journeyman's Small Mallet**  
**31 mm, 340 g**  
 Part No. **05K15-01**



**NEW!**  
**VERITAS**  
**Journeyman's Large Mallet**  
**41 mm, 510 g**  
 Part No. **05K15-03**



**NEW!**  
**CARBATEC**  
**Automatic Centre Punch Tool**  
 Part No. **CT-ACP**



**NEW!**



- 1** NAREX 140 mm Traditional Carpenters Mallet – Part No. **NRX-825300**
- 2** NAREX 290 mm Anti-Reflex Bounceless Mallet – Part No. **NRX-875102**
- 3** NAREX 170 mm Traditional Joiners Mallet – Part No. **NRX-825110**
- 4** NAREX Conical Scratch Awl – Part No. **NRX-874610**
- 5** NAREX Marking Knife – Part No. **NRX-822301**



**KUTZALL**  
Tungsten Carbide  
8" Flat Hand Rasp Fine  
Part No. **KUTZ-FT8170**



**KUTZALL**  
Tungsten Carbide  
8" Flat Hand Rasp Coarse  
Part No. **KUTZ-FT8330**



**KUTZALL**  
Tungsten Carbide  
6" Half-Round Rasp Fine  
Part No. **KUTZ-HR6170**



**KUTZALL**  
Tungsten Carbide  
6" Half-Round Rasp Coarse  
Part No. **KUTZ-HR6330**



**KUTZALL**  
Tungsten Carbide  
6" Warding Rasp Fine  
Part No. **KUTZ-WD6170**



**KUTZALL**  
Tungsten Carbide  
6" Warding Rasp Coarse  
Part No. **KUTZ-WD6330**



**CARBATEC**  
8 Pce Riffler Rasp Set  
Part No. **CT-RIFFLER-8PCE**



**CARBATEC**  
Diamond File Set  
Part No. **DF-10**

**NEW!**

**NAREX**  
Fine Machine Cut Round  
200 mm Rasp  
Part No. **NRX-872562**

**NAREX**  
Coarse Machine Cut Round  
200 mm Rasp  
Part No. **NRX-872512**

**NAREX**  
Fine Machine Cut Flat  
200 mm Rasp  
Part No. **NRX-872552**

**NAREX**  
Coarse Machine Cut Flat  
200 mm Rasp  
Part No. **NRX-872502**

**NAREX**  
Fine Machine Cut Half Round  
200 mm Rasp  
Part No. **NRX-872572**

**NAREX**  
Coarse Machine Cut Half Round  
200 mm Rasp  
Part No. **NRX-872522**





**MTC**  
Japanese Bevel Edge Chisels  
9 Pce set, 6-38 mm  
Part No. **MBC-SET**



**TOPMAN**  
Japanese Chisels  
6 Pce set, 6-30 mm  
Part No. **JCS-6**



**pfeil** SWISS MADE

**PFEIL**  
Cabinet Makers Chisels  
6 Pce set, 6-26 mm  
Part No. **PF-CM-SET-6**



**MTC**  
Japanese Butt Chisel 1"  
Carbon Vanadium  
Part No. **MBC-1-N**



**MTC**  
Japanese Butt Chisel 1/2"  
Carbon Vanadium  
Part No. **MBC-12-N**



**MTC**  
Japanese Butt Chisel 3/8"  
Carbon Vanadium  
Part No. **MBC-38-N**



**MTC**  
Japanese Butt Chisel 3/4"  
Carbon Vanadium  
Part No. **MBC-34-N**



**MTC**  
Japanese Butt Chisel 1/4"  
Carbon Vanadium  
Part No. **MBC-14-N**



**NAREX**  
Wood Line Bevel Edge  
Chisel Set - 4 pieces  
Part No. **NRX-863010**

Also available  
in 6-piece set, in wooden case  
Part No. **NRX-853055**



**NAREX**  
Wood Line Plus Series  
Bevel Edge Chisel Set - 4 pieces  
Part No. **NRX-863201**

Also available  
in 6-piece set, in wooden case  
Part No. **NRX-853250**

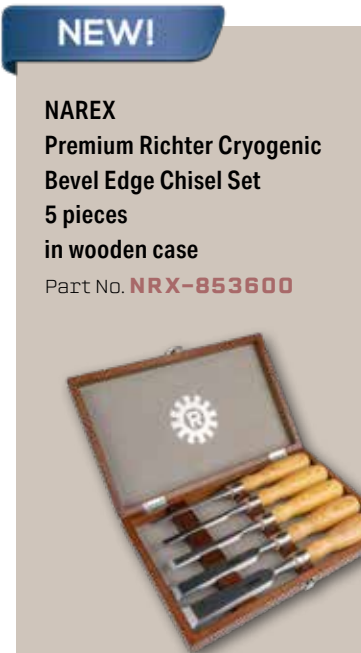

**NAREX**  
Premium Richter Cryogenic  
Bevel Edge Chisel Set  
5 pieces  
in wooden case  
Part No. **NRX-853600**



# SCRAPERS, BURNISHERS & HANDPLANES



PAX SAWS

**PAX Cabinet Scraper Set - Rectangular - 4 pieces**  
Part No. **PAX-SS2**



PAX SAWS

**PAX Concave Scraper Set - 0.8 mm 3 pieces, 1/4" to 1-1/2"**  
Part No. **PAX-CC**



PAX SAWS

**PAX Convex Scraper Set - 0.8 mm 3 pieces, 1/4" to 1-1/2"**  
Part No. **PAX-CV**



pfeil SWISS MADE

**PFEIL Oval Burnisher**  
Part No. **PF-BURN-OVAL**



LeeValley

**LEE VALLEY Super Hard Cabinet Scraper Set 4 pieces**  
Part No. **05K30-10**



LeeValley

**LEE VALLEY Super Scraper Set 0.4 mm - 3 pieces**  
Part No. **05K20-20**



veritas

**VERITAS Variable Burnisher with Blade**  
Part No. **05K37-01**



veritas

**VERITAS Mini Carbide Burnisher**  
Part No. **05K20-30**



veritas

**VERITAS Scraper Holder 6"**  
Part No. **05K33-01**



veritas

**VERITAS Jointer/Edger**  
Part No. **05M07-01**



veritas

**VERITAS Large Router Plane**  
Part No. **05P38-01**



veritas

**VERITAS Flush Plane**  
Part No. **05P20-01**



**GROZ**  
Standard Block Plane  
Part No. **GZ-220N**



**GROZ**  
Low-Angle Block Plane  
Part No. **GZ-605N**



**GROZ**  
Smoothing Plane - No. 4  
Part No. **GZ-39701**



**GROZ**  
Smoothing Plane - No. 5  
Part No. **GZ-39702**



**GROZ**  
Jointing Plane - No. 7  
Part No. **GZ-39704**



**VERITAS**  
Low Angle Smoothing Plane  
with PM-V11 Blade  
Part No. **05P25-71**  
Optional blade also available.



**VERITAS**  
Standard Block Plane  
with PM-V11 Blade  
Part No. **05P22-81**



**VERITAS**  
Low-Angle Block Plane  
with PM-V11 Blade  
Part No. **05P22-71**



**VERITAS**  
Bevel-Up Smoother Plane  
with PM-V11 Blade  
Part No. **05P36-71**



**VERITAS**  
Low-Angle Jack Plane  
with PM-V11 Blade  
Part No. **05P34-71**



**VERITAS**  
Round Spokeshave  
with PM-V11 Blade  
Part No. **05P33-74**



**VERITAS**  
Flat Spokeshave  
with PM-V11 Blade  
Part No. **05P33-73**

*A comprehensive range of hand tools is available.  
Please contact us or visit our website for more information.*



**KUNZ®**



**KUNZ**  
Beaver Tail Pocket Plane 85 x 24 mm  
Part No. **KU-100**



**KUNZ**  
Pocket Plane 85 x 24 mm  
Part No. **KU-101**



**KUNZ**  
Scraper Plane  
Part No. **KU-112**



**KUNZ**  
#75 Bull Nose Plane  
Part No. **KU-PLANE-75**



**KUNZ**  
#78 Rebate Plane  
Part No. **KU-PLANE-78**



**KUNZ**  
9-1/2 Block Plane  
Part No. **KU-PLANE-912**



**KUNZ**  
220 Block Plane  
Part No. **KU-PLANE-220**



**KUNZ**  
#4 Hand Plane  
Part No. **KU-PLANE-4**



**KUNZ**  
#5 Hand Plane  
Part No. **KU-PLANE-5**



**KUNZ**  
#7 Hand Plane  
Part No. **KU-PLANE-7**



**KUNZ**  
Flat Face Spokeshave  
Part No. **KU-51A**



**KUNZ**  
Round Sole Spokeshave  
Part No. **KU-51AR**



**KUNZ**  
Light Spokeshave Curved Bottom  
Part No. **KU-63**



**KUNZ**  
Cabinet Scraper  
Part No. **KU-80**



**KUNZ**  
Hand Scraper 0.8 mm Thick  
Part No. **KU-13-117**



**KUNZ**  
Curved Hand Scraper  
Part No. **KU-13-119**



**KUNZ**  
Trammel Points  
Part No. **KU-40**



**KUNZ**  
Veneering Hammer  
Part No. **KU-104**



**carbatec**



**CARBATEC**  
Wide Foot Pipe Clamp  
Suits 3/4 threaded pipe  
Part No. **CT-PIPE**



**CARBATEC**  
External Mitre Clamp  
Part No. **TV-286**



**CARBATEC**  
Internal Mitre Clamp  
Part No. **TV-276**



**CARBATEC**  
Double Bar Clamp  
Single clamp hardware only  
Part No. **YF-00101**



**CARBATEC**  
Band Clamp Cloth  
Max 3.5 m  
Part No. **96601**

**wolcraft®**



**WOLCRAFT**  
EHZ "PRO" One-Hand Clamp  
300 mm capacity  
Part No. **WLF-PRO-65300**  
Available from 150-300 mm



**WOLCRAFT**  
EHZ "PRO" One-Hand Clamp  
300 mm capacity, Range 1  
Part No. **WLF-PRO-100300**  
Available from 150-915 mm



**WOLCRAFT**  
EHZ Miniature One-Hand Clamps  
(2 Pack) - 110 mm capacity  
Part No. **WLF-EASY-40110**



**WOLCRAFT**  
EHZ "Easy" One-Hand Clamp  
150 mm capacity, Range 1  
Part No. **WLF-EASY-75150**  
Available from 190-500 mm



**WOLCRAFT**  
KS 24 Edge Clamp  
Part No. **WLF-EDGECLAMP**



**WOLCRAFT**  
FZH Spring Clamp with Hook  
Part No. **WLF-FZH50HANG**



**WOLCRAFT**  
Connector PRO/Easy One-Hand  
Clamp Adapter  
Part No. **WLF-EHZ-CONNECT**



**WOLCRAFT**  
ES 22 Corner Clamp (2 Pack)  
Part No. **WLF-ES22-2PK**



**WOLCRAFT**  
FZH Ergo Spring Clamp  
Part No. **WLF-FZH30**  
Also available:  
FZH Ergo Spring Clamp 2



**WOLCRAFT**  
FZ Spring Clamp  
Range 1  
Part No. **WLF-FZ40**  
Also available:  
FZ Spring Clamp Range 2



**WOLCRAFT**  
Microfix Mini Spring Clamp  
Part No. **WLF-MFIX20**  
Colour may vary



**WOLCRAFT**  
Microfix Spring Clamps  
(4 Pack)  
Part No. **WLF-MFIX30-4PK**



**WOLCRAFT**  
Microtip 60 Precision  
Spring Clamps (2 Pack)  
Part No. **WLF-MTIP-2PK**



**KREG  
Automaxx™ 90°  
Corner Clamp**

Part No.

**KR-KHCCC**



**KREG  
3" Face Clamp**

Part No. **KR-KHC-PREMIUM**



**KREG  
3" Automaxx™  
Wood Project Clamp**

Part No. **KR-KHC3**



**KREG  
6" Automaxx™  
Wood Project Clamp**

Part No. **KR-KHC6**



**KREG  
Automaxx™  
Right Angle Clamp**

Part No. **KR-KHCRA**



**ROCKLER  
Frame Clamp Kit**

Part No. **RK-17477**



**ROCKLER  
Heavy Duty Clamp Rack**

Part No. **RK-57164**



**ROCKLER  
Sure-Foot Plus  
3/4" Pipe Clamp**

Part No. **RK-30921**

Pipe not included



**ROCKLER  
36" Sure-Foot Aluminium  
Bar Clamp (900 mm)**

Part No. **RK-41815**

Also available in 48" (1200 mm)

Part No. **RK-41816**



**ROCKLER  
F-Style Clamp Rack**

Part No. **RK-34302**

Clamps not included



**ROCKLER  
Pipe Clamp Rack/  
Bar Clamp Rack**

Part No. **RK-33547**

Clamps not included





**GROZ**  
150 mm Clamp-On Woodworking Vice  
Part No. **GZ-39006**



**GROZ**  
T-Bar Clamp  
750 mm capacity  
Part No. **GZ-39100**

Also available in:

1050 mm capacity - Part No. **GZ-39101**

1350 mm capacity - Part No. **GZ-39102**

1660 mm capacity - Part No. **GZ-39103**



**GROZ**  
222 mm Quick-Release Vice  
Part No. **GZ-39009**



**GROZ**  
175 mm Quick-Release Vice  
Part No. **GZ-39007**



**GROZ**  
175 mm Plain Screw Vice  
200 mm capacity  
Part No. **GZ-39001**



More than ninety  
BESSEY clamping solutions  
at [carbatec.co.nz](http://carbatec.co.nz)



**BESSEY**  
Needle Nose Spring Clamps  
Part No. **BES-XCL5**



**BESSEY**  
K Body Revo 2.0 Clamp  
2500 mm  
Part No. **BES-KRE250-2K**

Also available in:  
2000 mm, 1500 mm, 1250 mm,  
1000 mm, 800 mm, 600 mm,  
300 mm



**BESSEY**  
Hold-Down Workbench Clamp  
Part No. **TW162010-2K**



**BESSEY**  
One Hand Clamp  
300 mm  
Part No. **BES-EZS30-8**

Also available in:  
900 mm, 600 mm, 450 mm,  
150 mm

# SHARPENING

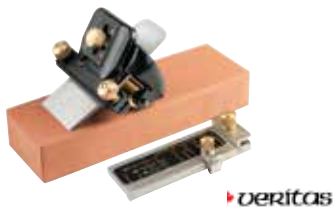

**VERITAS  
MK II Honing Guide**  
Part No. **05M09-01**  
Sharpening stone not included.



**VERITAS  
Side Clamping Guide Honing Guide**  
Part No. **05M09-40**



**DMT  
8\"/>**



**DMT  
8\"/>**



**CARBATEC  
Plane & Chisel Sharpening Guide**  
Part No. **CSG-21**  
Diamond plate not included.



**CARBATEC  
Economy Honing Guide**  
Part No. **MJ-817**  
Diamond plate not included.

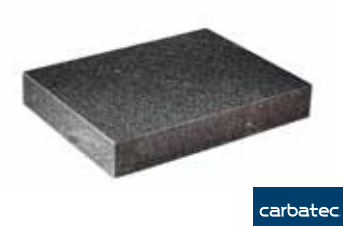

**CARBATEC  
Black Granite Surface Plate**  
Part No. **GSP-1**



**DMT  
DuoSharp Molded Base**  
Part No. **DMT-BB250**

**carbatec**

**CARBATEC  
750 W (1HP) 200 mm  
Low Speed Bench Grinder**  
Part No. **GR-S200P**



**CARBATEC  
Aluminium Oxide Grinding Wheel  
200 mm - 80 Grit**  
Part No. **GW-200-25-80**  
Also available in 150 mm.



**CARBATEC  
Bench Grinder Tool Rest Kit**  
Part No. **CT-CGJ-01**



**CARBATEC  
Bench Grinder Jig Accessory Kit**  
Part No. **CT-CGJ-ASSY**



**CARBATEC  
200 mm CBN Grinding Wheel  
25 mm x 5/8\"/>**



**CARBATEC  
Spindle and Gouge  
Sharpening System**  
Part No. **CT-SGSS-01**





**TORMEK Square Edge Jig**  
Part No. **TOR-SE-77**



**TORMEK Truing Tool**  
Part No. **TOR-TT-50**



**TORMEK Tool Rest Jig**  
Part No. **TOR-SVD-110**



**TORMEK T8 Water Cooled Grinder**  
Part No. **TOR-T8**



**TORMEK T4 Sharpening System**  
Part No. **TOR-T4**



*Robert Sorby*

**ROBERT SORBY ProEdge Ceramic Belt 120 grit**

Part No. **RSB-WPE120C**

Also available in 60 grit -

Part No. **RSB-WPE60C**



*Robert Sorby*

**ROBERT SORBY ProEdge Aluminium Oxide Belt 120 grit**

Part No. **RSB-WPE120A**

Also available in:

60 grit - Part No. **RSB-WPE60A**

240 grit - Part No. **RSB-WPE240A**

*Robert Sorby*



*Robert Sorby*

**ROBERT SORBY ProEdge Angle Setting Guide**

Part No. **RSB-WPROSET**



*Robert Sorby*

**ROBERT SORBY ProEdge Woodworkers' Square Guide**

Part No. **RSB-WPESQW**



**ROBERT SORBY ProEdge Deluxe Sharpening System**

Part No. **RSB-WPED01D**



carbatec

**CARBATEC**  
**Woodworking T-Square - 160 mm**

Part No. **CT-IM-TS160**  
Also available in 100 mm and 260 mm

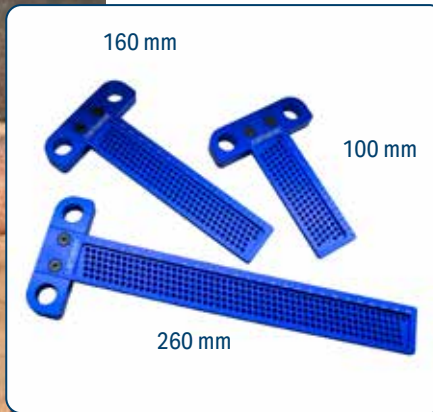

carbatec

**CARBATEC**  
**Combination Square Set**  
Part No. **CSQ-1625**



**TOPMAN**  
**Japanese Try Square**  
Part No. **49N0502**



**TOPMAN**  
**Shinwa Carpenter's Square**  
**30 x 15 cm**  
Part No. **JTM-1884-008**



**TOPMAN**  
**Shinwa Straight Scale Rule**  
**with stopper - 150 mm**  
Part No. **JTM-1929-310**



**TOPMAN**  
**Shinwa Ruler Pick Up Scale**  
**Silver - 30 cm**  
Part No. **JTM-1929-003**

**INCRA**



**INCRA**  
**Professional T-Rule - 150 mm**  
Part No. **IN-TDPROT06**  
Also available in 300 mm: Part No. **IN-TDPROT12**

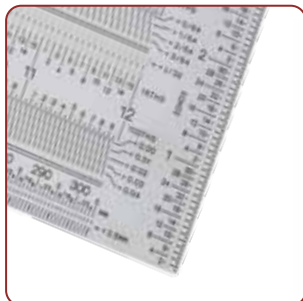

**INCRA**  
**Centering Rule - 300 mm**  
Part No. **IN-CENT300M**



**INCRA**  
**Precision Bend Rule - 300 mm**  
Part No. **IN-BND300M**  
Also available in 150 mm:  
Part No. **IN-BND150M**



**INCRA**  
**Rule - 150 mm**  
Part No. **IN-TRUL150M**  
Also available in 300 mm: Part No. **IN-TRUL300M**



**INCRA**  
**Precision Protractor 160 mm**  
Part No. **IN-PRO160M**





**CARBATEC**  
Flexible Curve With Ruler  
600 mm

Part No. **D-00503**



**VERITAS**  
Metric 150 mm Edge Rules

Part No. **05N46-61**



**VERITAS**  
Metric 300 mm Edge Rules

Part No. **05N46-62**



**GROZ**  
Stainless Steel Rule - 600 mm

Part No. **GZ-01343**

Also available in 1000 mm:

Part No. **GZ-01344**



**CARBATEC**  
Carbatec Self Adhesive Rule -  
762 mm (30")

Part No. **76030**



**KREG**  
3.5 Metre  
Right to Left Tape

Part No. **KR-KMS7728**

Also available in Left to Right:

Part No. **KR-KMS7729**

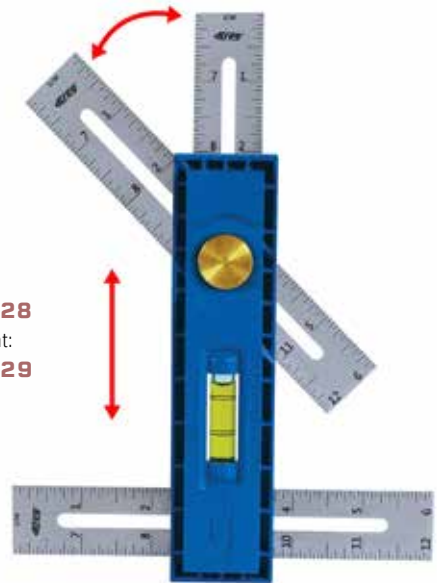

**KREG**  
Multi Mark

Part No. **KR-KMA2900**



**SOBA**  
9" Rosewood Sliding Bevel

Part No. **CT-260435**

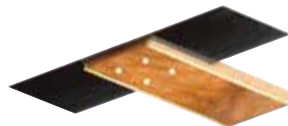

**SOBA**  
Rosewood & Brass 45°  
Mitre Square

Part No. **CT-260505**



**VERITAS**  
Wheel Marking Gauge

Part No. **05N33-21**



**VERITAS**  
Metric Graduated Marking Gauge

Part No. **05N35-21**



**VERITAS**  
Dual Marking Gauge

Part No. **05N70-01**



# FESTOOL



**FESTOOL**  
TS 55F 160 mm Plunge Cut  
Circular Saw  
in Systainer  
Part No. **FE-576705**



**FESTOOL**  
TS 55F 160 mm  
Plunge Cut Circular Saw  
in Systainer with 1400 mm Rail  
Part No. **FE-561655**



**FESTOOL**  
OF 1400 70 mm  
Plunge Router in Systainer  
Part No. **FE-576211**  
Also available in 80 mm:  
Part No. **FE-576217**



**FESTOOL**  
DF 500 DOMINO  
Joining Machine in Systainer  
Part No. **FE-576416**  
Also available:  
DF 700 DOMINO XL Joining Machine Plus  
in Systainer  
Part No. **FE-576429**

**FESTOOL**  
Domino DF 500 Set Version Kit  
Part No. **FE-574872**



**FESTOOL**  
KS 120R KAPEX 260 mm  
Slide Compound Mitre Saw  
Part No. **FE-575307**



**FESTOOL**  
ISC 240 Li EB-Basic  
Cordless Insulated Saw  
Part No. **FE-576571**





**FESTOOL**  
**RO 150 mm Rotex 3 en 1**  
**Random Orbital Sander**  
**in Systainer**  
 Part No. **FE-576019**



**FESTOOL**  
**ETS 150 mm Random Orbital Sander**  
**in Systainer**  
 Part No. **FE-576076**



**FESTOOL**  
**ETS 150 mm Random Orbital 5 mm Sander**  
**in Systainer**  
 Part No. **FE-576084**



**FESTOOL**  
**CT 15 Litre HEPA Class Dust Extractor**  
 Part No. **FE-574866**



**FESTOOL**  
**CTM 26 Litre M Class Dust Extractor**  
 Part No. **FE-575758**



**FESTOOL**  
**CTM 36 Litre M Class Dust Extractor**  
 Part No. **FE-576741**



**TRITON**  
**SuperJaws XXL Portable**  
**Clamping System**  
 Part No. **TRI-SJA100XL**



**TRITON**  
**2400W Dual Mode Precision Plunge Router**  
 Part No. **TRI-TRA001B**



**NEW!**

**TRITON**  
**650W Portable Oscillating**  
**Spindle Sander**  
 Part No. **TRI-TSPSP650**



Find all the Carbatec router table kit options and the accessories available individually at [carbatec.co.nz](http://carbatec.co.nz)



**CARBATEC Router Table Mitre Gauge**  
Part No. **RT-MITREGAUGE**



**CARBATEC Router Table Premium Guard**  
Part No. **RT-GUARDASSY**



**CARBATEC Router Mounting Plate**  
Part No. **RT-MOUNTPLATE**

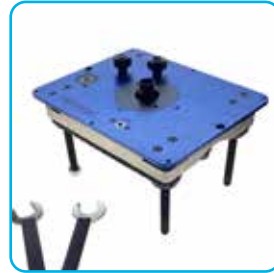

**CARBATEC Lift N Lock Router Lift**  
Suits fixed base routers  
Part No. **RT-LIFT-FB**



**CARBATEC 2400W Router Power Unit**  
Part No. **RT-RPU2400**



**CARBATEC Precision Router Table Fence**  
Part No. **RT-FENCE-L**



**CARBATEC Pro Cast Iron Router Table Top only**  
Part No. **RT-TABLECAST-L**



**CARBATEC Router Table Inserts**  
Part No. **RT-LIFT-INSERTS**

A huge range of CMT and ARDEN individual router bits and bit sets are available.



carbatec

**CARBATEC**  
Brass Router Bushing Set  
Part No. **RM-9**



carbatec

**CARBATEC**  
Universal Router Base Plate  
Part No. **CT-BPA-1**



titon

**TRITON**  
Template Guide Kit -  
12 pce  
Part No. **TRI-TGA250**

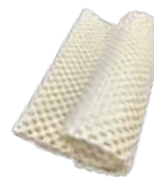

carbatec

**CARBATEC**  
Router Mat - 900 x 600  
Part No. **P-2436**



ROCKLER  
WOODWORKING AND HARDWARE

**ROCKLER**  
2 1/4 Interlock Signmaker's  
Lettering Kit  
Part No. **RK-30610**



Kreg

**KREG**  
Large Router Table System  
Part No. **KR-PRS1045**

Kreg

**KREG**  
Benchtop Router Table  
Part No. **KR-PRS2100**



**carbatec**

**CARBATEC**  
**Brad Point Bit Set**  
 1, 1.5, 2, 2.5, 3, 3.5,  
 4, 4.5, 5, 5.5, 6, 6.5,  
 7, 7.5, 8, 8.5, 9, 9.5,  
 10, 10.5, 11, 11.5, 12,  
 12.5 & 13 mm  
 Part No.  
**BPD-25PCE**



**carbatec**

**CARBATEC**  
**16 Piece Sawtooth & Forstner Combination Bit Set - Metric**  
 Part No. **CT-STB16PCE-M**  
 Also available in imperial  
 Part No. **CT-STB16PCE-I**



**carbatec**

**CARBATEC**  
**15 Piece Forstner Bit Set - Metric**  
 Part No. **CT-FSB15PCE-M**



**carbatec**

**CARBATEC**  
**Carbatec Forstner Bit Extension**  
 Part No. **EXTN-1**



**CMT**

**CMT**  
**5 Piece**  
**Brad Point**  
**Drill Set**  
 Part No.  
**517-001-00**



**CMT**

**CMT**  
**8 Piece**  
**Brad Point**  
**Drill Set**  
 Part No.  
**517-002-00**



**carbatec**

**CARBATEC**  
**Drill & Barrel Plug 8pce cutter Set**  
**Small**  
 Part No. **PSG-8PCE-S**



**carbatec**

**CARBATEC**  
**Drill & Barrel Plug 8pce cutter Set**  
**Large**  
 Part No. **PSG-8PCE-L**



**ARCHER**

**ARCHER**  
**Archer 8 Piece Plug cutter Set**  
 Part No. **PCS-8PCE**



**veritas**

**VERITAS**  
**Metric Snug Plug cutter Set - 3 pce**  
 Part No. **05J05-50**

**CARBATEC**  
**6 Piece Barrel Plug cutter Set**  
 Part No. **PLUG-6**

**carbatec**





carbatec

**CARBATEC**  
**Compact Mitre Box - 600 mm Blade**

Part No. **CPTC-600**

Replacement blades available for:

CPT-600 - 24TPI - Part No. **CPTC-600-24T**

CPT-600 - 18TPI - Part No. **CPTC-600-18T**

CPT-600 - 14TPI - Part No. **CPTC-600-14T**



carbatec

**CARBATEC**  
**Compact Mitre Box - 550mm Blade**

Part No. **CPT-550**

Replacement blades available for:

CPT-550 - 24TPI - Part No. **CPT-550-24T**

CPT-550 - 18TPI - Part No. **CPT-550-18T**



carbatec

**CARBATEC**  
**Compact Mitre Box - 350mm Blade**

Part No. **CPT-350**

Replacement blades available for:

CPT-350 - 14TPI - Part No. **CPT-350-14T**

CPT-350 - 18TPI - Part No. **CPT-350-18T**



carbatec

**CARBATEC**  
**Mitre Trimmer**

Part No. **CT-MT**



**ZETSAW**  
**Japanese Compound**  
**Saw Guide and**  
**S-265 KATABA Set**

Part No. **Z-8008**



Replacement blade available:

Part No. **Z-8008-B**





**LEIGH**  
Super Jig 12" (305 mm) with Metric Scales

Part No. **LGH-SJ12M**

Also available in 18" (457 mm)

Part No. **LGH-SJ18M**



**LEIGH**  
D4R Pro Dovetail Jig with Metric Scales

Part No. **LGH-D4R**



**LEIGH**  
RTJ400 Router Table Dovetail Jig

Part No. **LGH-RTJ400**



**LEIGH**  
GBS Adaptor to suit  
some Hitachi and Makita

Part No. **LGH-703**



**LEIGH**  
Box Joint & Beehive Jig

Part No. **LGH-B975**



**LEIGH**  
1/2" to 8 mm Reducer

Part No. **LGH-172-8**



**CMT**  
Dovetail Router Bit - 10°

Part No. **818-133-11**



**CARBATEC**  
14" Dovetail Bit

Part No.

**CT-DTJ300-DB14**

**CARBATEC**  
Half Blind Dovetail Jig 300 mm with Router Bit

Part No. **CT-DTJ300**





**KREG**  
**Wood Blue-Kote Screw Kit**  
Part No. **KR-SK03B**



**KREG**  
**Wood Pocket-Hole Screw Kit**  
Part No. **KR-SK03**



**KREG**  
**HD Pocket Hole Jig XL**  
Part No. **KR-KPHJ920**



**KREG**  
**320 Pocket-Hole Jig**  
Part No. **KR-KPHJ320**



**KREG**  
**520PRO Pocket-Hole Jig**  
Part No. **KR-KPHJ520PRO**



**KREG**  
**720PRO Pocket-Hole Jig**  
Part No. **KR-KPHJ720PRO**



SawStop's patented safety system stops a spinning blade on contact with skin. The blade stops in less than 5 milliseconds and drops below the table, minimising a potentially life-altering injury to a mere scratch.



**SAWSTOP PROFESSIONAL Cabinet Saw with 36\"/>**

Part No. **SST-PCS36TGLIDE**

- 2200 W (3 HP) induction
- Max rip capacity: 914 mm
- Footprint (W×D×H): 1770×1060×1050 mm

Also available:

- Professional Cabinet Saw with 30\"/>



**SAWSTOP INDUSTRIAL Cabinet Saw with 36\"/>**

Part No. **SST-ICS36TGLIDE**

- 2200 W (3 HP) induction
- Max rip capacity: 914 mm
- Bigger hand wheels, larger motor access door, second access door
- Perfect for high cycle environments
- 90 kg+ of cast iron and steel
- Thicker and deeper cast iron table
- Larger and deeper T-Glide fence
- Safety switch on access doors
- Footprint (W×D×H): 1755×1015 mm

Also available:

- Industrial Cabinet Saw with 52\"/>



**SAWSTOP Dust Collection Arm**

Part No. **SST-TSA0DC**



**SAWSTOP Industrial Mobile Base for Professional Cabinet Saw**

Part No. **SST-MBPCSIND**



**SAWSTOP Integrated Mobile Base for Professional Cabinet Saw**

Part No. **SST-MBPCS000**



**SAWSTOP 10\"/>**

Part No. **SST-TSBC10R3**



**SAWSTOP Large Sliding Table**

Part No. **SST-TSA-SA70**



**SAWSTOP Sliding Crosscut Table**

Part No. **SST-TSASA48**



**SAWSTOP Folding Outfeed Table**

Part No. **SST-TSA-FOT**



**SAWSTOP Floating Overarm Dust Collection**

Part No. **SST-TSG-FDC**







**SAWSTOP**  
40 Tooth Titanium Series Blade  
Part No. **SST-BTSR40ATB**



**SAWSTOP**  
80 Tooth Titanium Series Blade  
Part No. **SST-BTSP80HATB**



**SAWSTOP**  
Standard 40 Tooth 10" Blade  
Part No. **SST-CNS07148**  
Also available in 60 teeth:  
Part No. **SST-CB104184**



**SAWSTOP**  
24T Ripping Blade  
Part No. **SST-BTSR24ATB**



**AMANA TOOLS**  
10" Prestige Electro-Blu Flat  
Tooth Grind Ripping Blade  
Part No. **AM-610240C**



**CMT**  
Industrial Rip and Crosscut  
Blade - 250mm - 60 Tooth  
Part No. **285-060-10M**



**CMT**  
Industrial Low Noise and  
Chrome Coated Blade -  
80 Tooth 15° - ATB Grind  
Part No. **285-680-10M**



**CMT**  
Precision Dado Set - 203 mm (8")  
5/8" bore  
Part No. **230-524-08**



**LAGUNA**

**LAGUNA**  
2021 Fusion 2 F2 Table Saw  
Part No. **LGT-FUSION2**

- 1300W (1.75 HP)
- Max rip capacity: 910 mm right, 430 mm left
- Dado capable 19 mm max.
- Footprint (WxDxH): 1663x1652x1081 mm



**carbatec**

**CARBATEC**  
Omni-Directional Mobile Base  
Part No. **CT-MB-OMNI**



**LAGUNA**

**LAGUNA**  
2021 Fusion 3 F3 Table Saw  
Part No. **LGT-FUSION3-36**

- 2200W (3 HP)
- Max rip capacity: 910 mm right, 430 mm left
- Dado capable 19 mm max.
- Cast iron cabinet mount trunnion
- Outfeed table
- 36" steel rails
- Footprint (WxDxH): 1663x1652x1081 mm



**carbatec**

**CARBATEC**  
SawStop 10" Compact Table Saw  
Part No. **SST-CTS10**

- Motor 2100W Peak, Standard 10amp Plug
- Max rip capacity: 648 mm
- Footprint (WxDxH): 596 x 685 x 368 mm



LAGUNA

**LAGUNA**  
Laguna 16" 3 HP  
Sheartec II Thicknesser

- Part No. **LGT-TH-16**
- 2200 W (3 HP) induction motor
  - Sheartec II helical cutterhead
  - Max. cutting width 406 mm
  - Integral digital height gauge



carbatec

**CARBATEC**  
13" Spiral Head Benchtop  
Thicknesser

- Part No. **TH-BX330P**
- Motor 1.8kW (2.4HP) Brushed, 10A plug
  - Cutterhead Segmented Spiral - 2 sided blades
  - Max. cutting width 330 mm
  - Cutting depth gauge

**CARBATEC**  
20" 3 ½ HP Thicknesser with  
Helical Cutterhead

carbatec

- Part No. **TH-X508C**
- 2600 W (3 ½ HP) induction motor
  - True helical cutterhead with 98 insert knives
  - Max. cutting width 508 mm



**NEW!**

Best value replacement carbide inserts  
now available.

**Carbatec Premium Carbide Inserts**  
14.33x2mm Square - 2 edges  
Pk10

- Part No. **CTI-143320-Z2**  
Available in 6 varieties.



carbatec

**CARBATEC**  
15" 3 ½ HP Thicknesser  
with Helical Cutterhead

- Part No. **TH-X381C**
- 2600 W (3 1/2 HP) induction motor
  - True helical cutterhead with 74 insert knives
  - Max. cutting width 381 mm



Instead of one full width blade striking the board, a true helical cutterhead features a series of smaller, four-sided solid carbide knives, wrapped around the cutterhead in a helical pattern. They carefully 'slice' their way through even the hardest of timber grain. Far quieter, far smoother finish than with a single blade.



carbatec

**CARBATEC**  
200 mm Spiral Head Benchtop Jointer with Euro Guard

Part No. **JN-BX200P**

- Motor 1100W (1-1/2 HP) Universal - Regular 10A Plug
- Switch Type Magnetic Switch NVR
- Cutterhead Spiral - 16 HSS cutters



carbatec

**CARBATEC**  
Deluxe 6" Jointer with NZ Guard

Part No. **JN-150C**

- Motor 0.75kW (1.0HP) Induction, 10A plug
- Switch Type Magnetic NVR
- Built-in castors help you position the machine easily
- Cutterhead Straight 3 knife



carbatec

**CARBATEC**  
8" Long Bed Helical Cutterhead Jointer with Parallelogram Tables

Part No. **JN-X200C**

- 1100 W (1 1/2 HP) induction motor
- Integral mobile base
- Parallelogram bed adjustment
- 4" Dust port
- Max. cutting width 200 mm

Also available with straight blade.



carbatec

**CARBATEC**  
6" Long Bed Helical Cutterhead Jointer with Parallelogram Tables

Part No. **JN-LX150C**

- 750 W (1 HP) induction motor
- Integral mobile base
- 4" Dust port
- Max. cutting width 150 mm

Also available with straight blade.

**NEW!**

Carbatec Premium Carbide Inserts are available in 6 varieties.



**NZ GUARDS**  
Different to images shown



carbatec

**CARBATEC**  
Planer Blade Setting Jig (Magnetic)

Part No. **PSJ-01**



carbatec

**CARBATEC**  
Push Block (Pair)

Part No. **PB-1**



carbatec

**CARBATEC**  
Twin Featherboard Set

Part No. **CT-FB-2PCE**



carbatec

**CARBATEC**  
Mitre Gauge

Part No. **MGT-02**



LAGUNA

**LAGUNA  
14/12 Bandsaw CE Model**

Part No. **LGT-1412**

- 1300 W (1-¾ HP) induction motor
- Laguna 5 piece ceramic guides
- Hi/Lo rip fence
- 330 mm cutting depth
- Footprint (W×D×H): 800×683×1784 mm



LAGUNA

**LAGUNA  
14BX Bandsaw CE Model**

Part No. **LGT-14BX**

- 1800 W (2-½ HP) induction motor
- Laguna 5 piece ceramic guides
- Hi/Lo rip fence
- 330 mm cutting depth
- Rigid frame construction
- Footprint (W×D×H): 755×713×1790 mm



LAGUNA

**LAGUNA  
18BX Bandsaw CE Model**

Part No. **LGT-18BX**

- 2200 W (3 HP) induction motor
- Laguna 5 piece ceramic guides
- Hi/Lo rip fence
- 406 mm cutting depth
- Rigid frame construction
- 460 mm ripping capacity
- Footprint (W×D×H): 919×759×1975 mm

Shown with optional wheels



carbatec

**CARBATEC  
14" (345 mm)  
Two Speed  
Bandsaw**

Part No. **BS-345H**



carbatec

**CARBATEC  
14" (345 mm) Heavy Duty High Capacity  
3HP Bandsaw**

Part No. **BS-X3453C**

- Powerful 2200 W (3 HP) induction motor
- Automatic electronic braking system
- Micro switched doors for safety
- Solid cast iron wheels
- Extra high cutting capacity - 360 mm
- Includes blade: ¾" × 6TPI
- Footprint (W×D×H): 740×850×1920 mm



carbatec

**CARBATEC  
21" (530 mm) Heavy Duty  
3HP Bandsaw**

Part No. **BS-530C**

- Powerful 2200 W (3 HP) induction motor
- Automatic electronic braking system
- Micro switched doors for safety
- Solid cast iron wheels
- Extra high cutting capacity - 300 mm
- Two blade speeds for different materials
- Includes blade: ¾" × 6TPI
- Footprint (W×D×H): 1002×727×1982 mm





**1**  
**CARBATEC**  
 Tail Vice Hardware  
 Part No. **CT-TV**

**2**  
**CARBATEC**  
 Shoulder Vice Hardware  
 Part No. **CT-SV**

**3**  
**CARBATEC**  
 Regular Front Vice Hardware  
 Part No. **CT-FV-R**

**4**  
**CARBATEC**  
 Large Front Vice Hardware  
 Part No. **CT-FV-L**

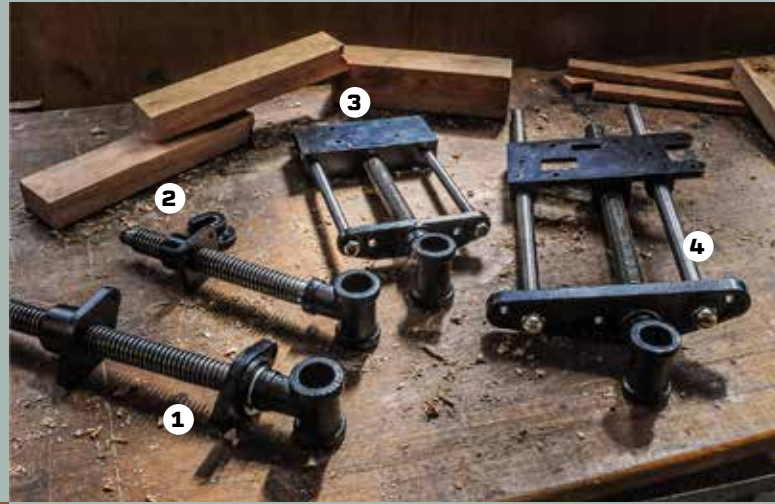

**5**  
**CARBATEC**  
 Swivelling Bench Vice 150 mm  
 Part No. **CT-SBV150**

**6**  
**CARBATEC**  
 Swivelling Bench Vice 100 mm  
 Part No. **CT-SBV100**

**7**  
**CARBATEC**  
 Clamp on Swivel Head Vice  
 Part No. **CT-SHV060**

**8**  
**CARBATEC**  
 125mm Swivelling & Rotating  
 Bench Vice  
 Part No. **CT-SHV125**

**9**  
**CARBATEC**  
 Low Profile Vice  
 Part No. **CT-LPV**

**CARBATEC**  
 Wide Foot Pipe Clamp Head  
 Part No. **CT-PIPE**

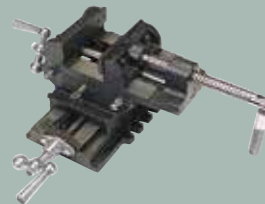

**CARBATEC**  
 4" Cross Slide Vice  
 Part No. **CSV-4**



**CARBATEC**  
 Parrot Vice  
 Part No. **PARROT-VISE**

**CARBATEC**  
 Pattern Makers and Guitar or  
 Luthier's Vice  
 Part No. **PATTERN-VISE**

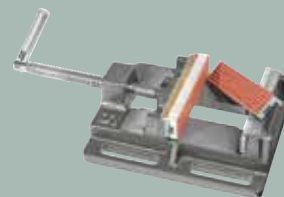

**CARBATEC**  
 4" Drill Press Vice  
 Part No. **GD-134/4**



**CARBATEC**  
 Heavy Duty Carver's Vice  
 Part No. **CV-236**



**TRITON  
TSPS T450 450 W  
Oscillating Spindle & Belt Sander**

Part No. **TRI-TSPST450**

- Large cast aluminium table with 0-45° tilting
- Rotating and vertically oscillating sanding action
- 450 W motor
- 5 different spindles included
- 80/150/240 G sleeve packs available



**CARBATEC  
300 mm Disc Sander  
with Brake & Half Guard**

Part No. **DS-B300H**

- 900 W (1-¼ HP) induction motor,
- 300 mm hook & loop sanding disc
- Easy adjust tilting table 0-45°
- Includes brake and jalf guard



**CARBATEC  
Benchtop Oscillating  
Spindle Sander**

Part No. **SPS-375P**

- 375 W (½ HP)
- 45° tilting table
- 25 mm x 30 oscillations per min.
- Includes 5 spindles and sleeves



**TRITON  
Oscillating Spindle Sander**

Part No. **TRI-TSPS450**

- Sturdy 450W motor
- 58 oscillations per minute
- No load speed 2,000 rpm



**CARBATEC  
Oscillating Edge Sander**

Part No. **WBS-2200C**

- 2200 W (3 HP) induction motor
- Height adjustable table
- 150 mm wide tilting belt
- Footprint (W×D×H): 1270×570×1200 mm



**CARBATEC  
Belt/Disc Sander wth Stand  
6" x 9"**

Part No. **BDS-1523H**

- Powerful ¾ HP motor
- Belt size 150 x 1220 mm
- Hook and loop disc
- Disc diameter 230 mm
- Footprint (W×D×H): 740×520×1400 mm





LAGUNA

**LAGUNA  
Supermax 19/38 Wide Drum  
Sander CE Model**

Part No. **LGT-WDS-1938**

Stand not included

- 1350 W (1-3/4 HP) induction motor
- 482 mm single pass / 965 mm double pass capacity
- Variable belt feed speed
- Footprint (W×D×H): 610×1016×610 mm (without stand)



carbatec

**CARBATEC  
400 mm 1hp Wide Drum  
Sander**

Part No. **WDS-4080P**

- 1HP induction motor
- 400 mm sanding width
- Drum speed: 1420 rpm
- Feed speed variable between 0.6 and 3 m per minute



LAGUNA

**LAGUNA  
Supermax 19/38 or 25/50  
Closed Cabinet Mobile Stand**

Part No. **LGT-WDS-STD-CLOS**

LAGUNA

**LAGUNA  
Supermax 19/38 or 25/50 Open Stand**

Part No. **LGT-WDS-STD-OPEN**

Wheels and sander not included



carbatec

**CARBATEC  
635 mm Wide Drum Sander - Twin Drum**

Part No. **WDS-630C**

- 2200 W (3 HP) induction motor
- 635 mm wide sanding capacity
- 135 mm maximum stock thickness
- Independent drum adjustment
- Footprint (W×D×H): 1130×780×1300 mm



LAGUNA

**LAGUNA  
SuperMax 16/32  
Wide Drum Sander  
with stand  
CE Model\***

Part No. **LGT-WDS-1632**

- 1100 W (1-1/2 HP) induction motor
- 405 mm single pass / 810 mm double pass capacity
- Quick adjust lever
- Footprint (W×D×H): 860×560×550 mm (without stand)

**carbatec**

**CARBATEC  
Benchtop  
Drill Press**  
Part No. **DP-B550P**

- 550 W (¾ HP) induction motor
- 16 speed
- 320 mm swing
- 320 mm chuck to table
- MT2



**carbatec**

**CARBATEC  
Pedestal Drill Press**

Part No. **DP-750P**

- 750 W (1 HP) induction motor
- 16 speed
- 360 mm swing
- 680 mm chuck to table
- MT2



**carbatec**

**CARBATEC  
Extra Heavy Duty  
Pedestal Drill Press**

Part No. **DP-1500C**

- 1500 W (2 HP) induction motor
- 12 speed
- 510 mm swing
- 550 mm chuck to table
- MT4



**carbatec**

**CARBATEC  
Radial Arm Drill Press**

Part No. **DP-R375H**

- 375 W (½ HP) induction motor
- 5 speed
- Max. 840 mm swing
- 700 mm chuck to table
- MT2



**Nova Drill Presses**

The world's most advanced drill press range, with unparalleled performance and versatility. Designed to handle a wide variety of materials with ease, using powerful direct drive motor technology. They run quieter and without vibration due to their belt-less design. RPM and torque are computer controlled. Electronic variable speed control in both forward and reverse directions and automatic cut off at preselected depth.

**nova™**

**NOVA  
Voyager DVR Drill Press**

Part No. **TK-58001**

- 1500 W (2 HP) direct drive motor
- 50-5500 rpm variable speed
- 450 mm swing
- 587 mm chuck to table
- MT2



**NOVA  
Viking 16" DVR Drill Press  
Floor Standing Model**

Part No. **TK-83709**

- 750 W (1 HP) direct drive motor
- 150-6000 rpm variable speed
- 406 mm swing
- 770 mm chuck to table
- MT2



**NOVA  
Viking 16" DVR Drill Press**

Part No. **TK-83701**

- 750 W (1 HP) direct drive motor
- 150-6000 rpm variable speed
- 406 mm swing
- 265 mm chuck to table
- MT2







carbatec

**CARBATEC  
400 mm Variable Speed Scroll  
Saw with Rotary Tool**

Part No. **SS-400H**

**SS-400H**

There's no better machine for making small or intricate projects, such as toys, puzzles, signs or ornaments, than a scroll saw! SS-400H features an integrated foot switch for hands-free switching and control. A flexible and detachable rotary tool is included to help add some personal touches to your work, sand, grind and even drill some small starter holes so you can experiment with pinhole and intricate scrolling.



A comprehensive selection of scroll saw blades is available. Please contact us or visit our website for further information.

**SS-530C**

This Carbatec scroll saw has been at the forefront of scroll saw technology for many years. Unlike other scroll saws, this machine has a tilting upper and lower arm instead of a tilting table. The operator can retain their natural stance for greater control, accuracy and safety.



carbatec

**CARBATEC  
21"  
Variable Speed  
Scroll Saw**

Part No.  
**SS-530C**

- 150 W (1/3 HP)
- Head tilts, not the table
- Most popular size
- Steel plate 345x597 mm
- 18 mm blade stroke
- 51 mm depth of cut



# LAGUNA

## Cyclone Dust Extractors

The particles in a cyclonic swirl increase in velocity, creating higher CFM (Cubic Feet per Minute) and higher static pressure.

Larger and heavier particles slow down when meeting the crossbar and settle in the drum. Only the finer dust gets carried with the air stream up through the centre vane, through to the filter. All workshop air is returned filtered through the HEPA or 1 Micron canister.



- ① **L-shaped dual mount motor bracket**  
*Reduces vibration with oversized vertical bracket*
  - ② **One-piece main plenum allows direct airflow**  
*Helps reduce resistance*
  - ③ **Radial steel fan**  
*Balanced to ISO 1940 standards*
  - ④ **Splitter inlet and sealed cap**  
*Made of rubber, not hard plastic*
  - ⑤ **Filter surface area up to 120% larger than competitors**  
*Canister paper made in Denmark*
  - ⑥ **Ingenious lift system eliminates flex hose**  
*Patented lift design creates strong seal*
  - ⑦ **High quality swiveling casters**  
*4" diameter and 3" diameter drum casters*
- Newly designed dual paddles**  
*Provides twice the cleaning*



**LAGUNA P-FLUX 1 Series Cyclone Dust Extractor**

- Part No. **LGT-PFLUX1B**
- 1100 W (1-1/2 HP) induction motor
  - 900 CFM max. airflow
  - 10.1"/H2O max. static pressure
  - 94 litres drum capacity
  - Footprint (W×D×H): 1168×610×1753 mm



**LAGUNA C-FLUX 3 Series Cyclone Dust Extractor**

- Part No. **LGT-CFLUX3B**
- 2200 W (3 HP) 32 A induction motor
  - 2253 CFM max. airflow
  - 11.2"/H2O max. static pressure
  - 174 litres drum capacity
  - Footprint (W×D×H): 1420×720×2350 mm



**LAGUNA P-FLUX 3 Series Cyclone Dust Extractor**

- Part No. **LGT-PFLUX3B**
- 2200 W (3 HP) 32 A induction motor
  - 1624 CFM max. airflow
  - 11.2"/H2O max. static pressure
  - 174 litres drum capacity
  - Footprint (W×D×H): 1300×700×2260 mm



carbatec

**CARBATEC Pleated Filter Cartridges to suit all Carbatec dust collectors**  
*Please contact us or visit our website for information.*



triton

**TRITON Dust Collection Bucket 23 litres**  
Part No. **TRI-DCA300**



LAGUNA

**LAGUNA A-Flux 1/2HP Room Air Filtration Unit**  
Part No. **LGT-AFLUX**  
*Replacement filter options available. Please contact us or visit our website for further information.*



carbatec

**CARBATEC 1700 CFM Room Air Filter**  
Part No. **AF-2000C**  
Also available 650 CFM Room Air Filter  
Part No. **AF-1000C**





carbatec

**CARBATEC  
In-Line Cyclone  
Dust Collector**

Part No. **CDC-INLINE-02**

- Unpowered unit connects to your existing dust collector or dust system
- Sits between your powered collector and your machines
- Footprint (W×D×H): 640×760×1480 mm

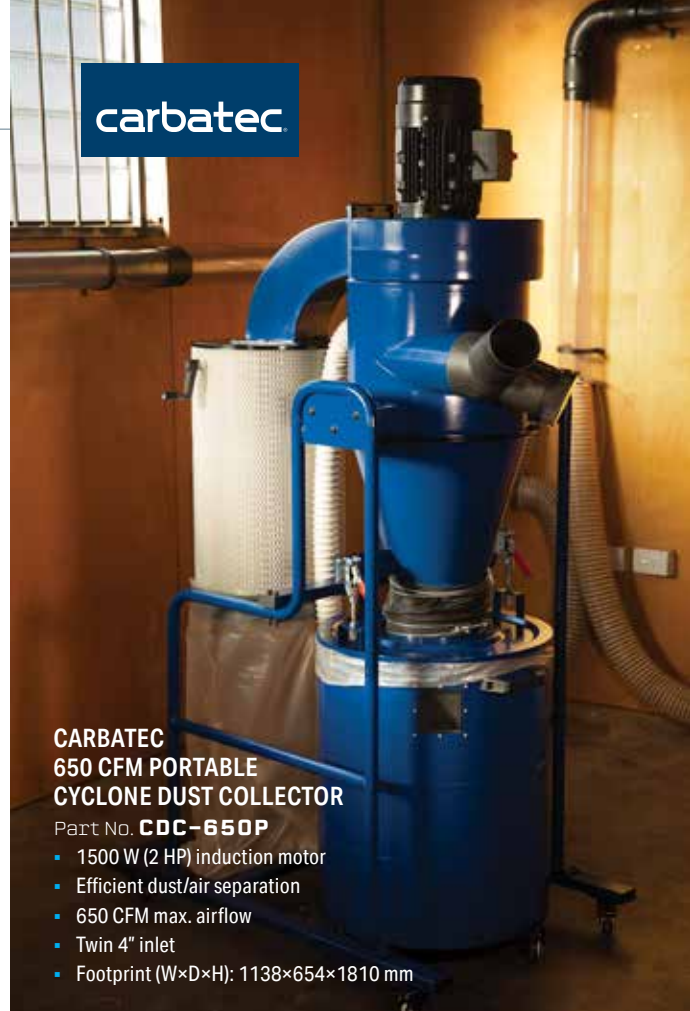

**CARBATEC  
650 CFM PORTABLE  
CYCLONE DUST COLLECTOR**

Part No. **CDC-650P**

- 1500 W (2 HP) induction motor
- Efficient dust/air separation
- 650 CFM max. airflow
- Twin 4" inlet
- Footprint (W×D×H): 1138×654×1810 mm

carbatec

**CARBATEC  
1200 CFM Portable Dust Collector**

Part No. **DC-1200P**

- 1500 W (2 HP) induction motor
- 1200 CFM max. airflow
- Twin 4" inlet
- Footprint (W×D×H): 560×850×1950 mm



**CARBATEC  
500 CFM Under Bench Dust Collector**

Part No. **DC-F500H**

- 750 W (1 HP) induction motor
- Can be wall mounted
- Optional cartridge filter available
- 500 CFM max. airflow
- Single 4" inlet
- Footprint (W×D×H): 450×1200×390 mm

**Why a dust-collector?**

A clean, dust-free work place is not only safer, but far less work in the long run. There is less clean-up and less airborne dust, which is very important when it comes to the finishing stage and your health. Carbatec offer many options in dust collection from small units designed for single machines to large units capable of connection to multiple machines.

carbatec

**CARBATEC  
850 CFM Portable  
Cyclone Dust Collector**

Part No. **CDC-850P**

- 1500 W (2 HP) induction motor
- Efficient dust/air separation
- 850 CFM max. airflow
- Triple 4" inlet
- Footprint (W×D×H): 660×1200×1750 mm



carbatec



A comprehensive range of hose, collection bags and dust fittings are available. Please contact us or visit our website for further information.

carbatec

**CARBATEC  
Professional Twin Bag  
Dust Collector**

Part No. **DC-2300P**

- 2100 W (2-3/4 HP) induction motor
- Massive dust holding capacity
- 1800 CFM max. airflow
- Triple 4" inlet
- Footprint (W×D×H): 1550×750×2220 mm





shown with optional accessories

LAGUNA

**LAGUNA**  
**Revo 12/16 Midi Lathe CE Model\***

Part No. **LGT-REVO-1216**

- 750 W (1 HP) induction motor
- 50-3000 rpm variable speed
- 24 position indexing
- 390 mm between centres
- 310 mm swing over bed capacity
- Footprint (W×D×H): 750×226×442 mm (without stand)



LAGUNA

**LAGUNA**  
**Revo 18/36 Lathe CE Model\***

Part No. **LGT-REVO-1836**

- 1500 W (2 HP) induction motor
- 50-3500 rpm variable speed
- 14/36/48 position indexing
- 910 mm between centres
- 450 mm swing over capacity
- Footprint (W×D×H): 1524×660×1194 mm



nova™

**NOVA**  
**Neptune Max 15" Digital Direct Drive Lathe**

Part No. **TK-55711**

- High-torque, 1.5 HP direct drive digital motor
- 100 rpm to 3500 rpm variable speed
- 15" (381 mm) inboard Swing with 28" (711 mm) between centres
- Headstock that swivels 360 degrees and slides along the full length of the bed
- Footprint (W×D×H): 490 x 1292 x 1198 mm



nova™

**NOVA**  
**Orion 18"x 22" DVR Lathe**

Part No. **TK-ORION**

- 1500 W (2 HP) direct drive motor
- 100-5000 rpm variable speed
- 24 position indexing
- 578 mm between centres
- 457 mm swing over capacity
- Footprint (W×D×H): 1130×597×1245 mm



nova™

**NOVA**  
**Neptune Midi Benchtop Lathe**

Part No. **TK-55701**

- High-torque, 1.5 HP direct drive digital motor
- 100-3500 rpm variable speed
- 15" (381 mm) Swing with 18" (457 mm) between centres
- Headstock that swivels 360 degrees and slides along the full length of the bed
- Footprint (W×D×H): 425×840×380 mm



### CARBATEC Benchtop Lathe

Part No. **WL-B1220H**

- 925 W input / 750 W (1 HP) universal motor
- 300-3500 rpm variable speed with digital readout
- 535 mm between centres
- 305 mm swing over capacity
- Footprint (W×D×H): 1030×310×410 mm



### CARBATEC Economy 900 mm Variable Speed Wood Lathe

Part No. **WL-900H**

- 560 W (3/4 HP) induction motor
- 500-2000 rpm variable speed
- 840 mm between centres
- 300 mm swing over capacity
- Footprint (W×D×H):  
1600×400×1120 mm



### CARBATEC Economy 1100 mm Variable Speed Wood Lathe

Part No. **WL-1100P**

- 1100 W (1-1/2 HP) induction motor
- 500-2000 rpm variable speed
- 1130 mm between centres
- 410 mm swing over capacity
- Footprint (W×D×H):  
2000×450×1200 mm



### CARBATEC 3 Point Spindle Steady Rest

Part No. **CT-WLREST-PRO**

- Reduce vibration of spindles from 1/2" to 3" in diameter. Easily adjusted for different diameters.



### CARBATEC 13 mm Drill Chuck - #2 MT

Part No. **HM-6**

- The large end of a Morse Taper 2 (MT#2) is approximately 18 mm

**Woodturning** is having a massive resurgence in popularity. Your project can be started and completed in a day with only a few basic tools and a lathe, available in a variety of sizes and configurations.

**Mini Lathes** are usually designed to be light enough to be moved onto a workbench and stored away when not being used. When choosing your mini lathe, consider its 'swing-over' capacity, and the maximum length between the head and tail stocks. This will dictate the maximum length of your completed project. It's a great start on your journey to learn to turn, with models available for just a few hundred dollars.

**Midi lathes** offer some extra 'swing-over' capacity and extra power. They can also be a full featured, full-size lathe, with a modified and shortened bed, giving you a compact footprint but more versatile machine. It's a great upgrade up from a mini lathe, where your skills are growing, but your workshop space isn't.

**Full-sized lathes** are for many turners the first and the last lathe they ever buy. Where space permits, a full-sized lathe is just as capable at small, intricate project work as it is at creating a four-poster bed. The widest choice of features, drive types, power etc. Many have outboard turning capabilities, to allow turning pieces of a very large diameter. Higher power for great control and quicker work.

*Robert Sorby*

Enormous range of individual chisels available at [carbatec.co.nz](http://carbatec.co.nz)



**ROBERT SORBY**  
6 piece Woodturning Starter Set  
Part No. **RSB-A67HS6T**



**ROBERT SORBY**  
18 Tool Modular Micro Set  
Part No. **RSB-A888HS18T**



**ROBERT SORBY**  
Drive Steb Centre 7/8in #2 MT  
Part No. **RSB-LSTB200**



**ROBERT SORBY**  
Pen Turning Set  
Part No. **RSB-A36HS3T**

**carbatec**



**CARBATEC**  
Economy Turning Chisel Set  
6 pce  
Part No. **TJ-6P**



**CARBATEC**  
Economy Miniature  
Turning Chisel Set - 3 pce  
Part No. **TJ-3**



**CARBATEC**  
Heavy Duty Dual-Bearing  
Live Centre #2 MT  
Part No. **MCL-202N**



**CARBATEC**  
Spur Drive 4 Prong #2 MT  
Part No. **MCL-222N**



**CARBATEC**  
Centre Finder - Plastic  
Part No. **CENTRE-FIND**



**CARBATEC**  
Premium HD Live Centre  
Part No. **MCL-302**



**SOBA**  
7 Piece  
Centre Punch Set  
Part No. **CT-180900**



**nova™**



**NOVA**  
SN2 Pro-Tek Chuck  
Part No. **TK-23262**



**NOVA**  
G3 Pro-Tek Chuck  
Part No. **TK-48290**

*Chucks require an insert.  
A range of inserts to suit most lathes are available separately. Please contact us.*



**NOVA**  
Centre System  
Part No. **TK-5015**



**NOVA**  
10 in 1 Chuck Gauge  
Part No. **TK-10051**



**carbatec**



**CARBATEC**  
3 Piece Tungsten Carbide  
Deep Swan Neck Hollowing  
Woodturning Chisel Set  
Part No. **CT-WTC-CHTS3**



**CARBATEC**  
3 Piece Cryogenic M2 HSS  
Medium Woodturning Chisel Set  
Part No. **CT-WTC-3S-CRYO**



**CARBATEC**  
3 Piece Tungsten Carbide  
and Stainless Steel  
Small/Medium Scraper Set  
Part No. **CT-WTC-RCT3**



**CARBATEC**  
6 Piece Cryogenic M2 HSS  
Medium Woodturning Chisel Set  
Part No. **CT-WTC-6S-CRYO**



**CARBATEC**  
4 Piece Tungsten Carbide  
and Stainless Steel  
Medium/Large Scraper Set  
Part No. **CT-WTC-RCT4**



**CARBATEC**  
6 Piece Cryogenic M2 HSS  
Large Woodturning Chisel Set  
Part No. **CT-WTC-6CT-CRYO**

**NEW!**

*Introducing the new range of individual chisels! Featuring the same high quality Cryogenic M2 HSS, with 63-65 Rockwell lasting 2-3x longer than regular M2 HSS, these chisels offer a way to expand your turning capacity.*



**CARBATEC**  
Cryogenic M2 HSS 2.3 mm  
Euro Parting Tool  
Part No. **CT-WTC-PT-32**



**CARBATEC**  
Cryogenic M2 HSS 38 mm  
Bowl Scraper  
Part No. **CT-WTC-BS-38**



**CARBATEC**  
Cryogenic M2 HSS 38 mm  
Round Nose Scraper  
Part No. **CT-WTC-RNS-38**



**CARBATEC**  
Cryogenic M2 HSS  
French Curve Negative Cut Scraper  
Part No. **CT-WTC-AS-2040**



**CARBATEC**  
Cryogenic M2 HSS 16 mm  
Bowl Gouge  
Part No. **CT-WTC-BG-16**  
Also available in 12 mm.



**CARBATEC**  
Cryogenic M2 HSS 16 mm  
Spindle Gouge  
Part No. **CT-WTC-SG-16**  
Also available in 6.35 mm.



**CARBATEC**  
Cryogenic M2 HSS 40 mm  
Roughing Gouge  
Part No. **CT-WTC-RG-40**



**Sandsheet Velcro 115 x 230 mm 120 Grit**

Part No. **SSV-120**

Also available in: 40, 60, 80, 180, 240, 320, 400 grit



**Wet and Dry Paper 1200 Grit**

Part No. **WD-1200**

Also available in: 600, 800, 2000 grit



**CARBATEC 20 Piece Drum Sanding Set 2 1/2" Long**

Part No. **DRUM-20L**

Replacement Sleeves for DRUM-20L Set:

Part No. **DRUM-20LS**



**CARBATEC Drum Sanding Spindle Set with Sanding Sleeves**

Part No. **CT-DS-4PCE**

Replacement Sleeves 80 grit:

Part No. **CT-DS-80G**

Replacement Sleeves 120 grit:

Part No. **CT-DS-120G**



**Sanding Belt 150 x 1220 mm 120 Grit**

Part No. **SB-1220-120**

Also available in: 40, 60, 80, 100, 120, 180, 240, 320 grit











**CARBATEC Belt/Disc Cleaning Stick - Large**

Part No. **BELT-CLEANER-L**

Also available in medium size.

**Sandpaper Wraps and Rolls for Wide Drum Sanders**

<b>WIDE DRUM SANDERS</b> 	 <b>WDS-4080P</b>	-	 <b>WDS-630C</b>
	 <b>LGT- WDS-1632</b>	 <b>LGT-WDS-1938</b>	 <b>LGT-WDS-2550</b>
<b>PRE-CUT WRAPS</b> 	<b>WDS-SP-60</b> <b>WDS-SP-80</b> <b>WDS-SP-120</b> <b>WDS-SP-180</b>	<b>CT-WDSP1938-060</b> <b>CT-WDSP1938-080</b> <b>CT-WDSP1938-120</b> <b>CT-WDSP1938-180</b>	<b>MS-SP-60</b> <b>MS-SP-80</b> <b>MS-SP-120</b>
	<b>25 METER ROLLS</b> 	<b>SPR-3-60-25</b> <b>SPR-3-80-25</b> <b>SPR-3-120-25</b> <b>SPR-3-180-25</b> <b>SPR-3-240-25</b>	<b>SPR-4-60-25</b> <b>SPR-4-80-25</b> <b>SPR-4-120-25</b> <b>SPR-4-180-25</b> <b>SPR-4-240-25</b>



**CARBATEC 5pce Sandpaper Strips**

Part No.

**CT-SPS-5**



**CARBATEC 5 Pce Mesh Sanding Kit**

Part No.

**CT-SMS-5**



**KUSTOM CREATIONS Kustom Blu-Sheen Wet Sanding Solution**

Part No. **KM-BLU**



*A comprehensive range of sandpaper sizes and grits is available. Contact us or visit our website for more information.*







**BOW PRODUCTS**  
Products GuidePro Bandsaw Guide  
Part No. **BOW-GP5**



**CARBATEC**  
BOW-PP1  
Part No. **PS-20**



**CARBATEC**  
Push Block & Stick Pack - 5 piece  
Part No. **CT-PBK-5PCE**



**BOW PRODUCTS**  
PushPro Push Stick  
Part No. **BOW-PP1**



**CARBATEC**  
Push Blocks - Pair  
Part No. **PB-1**



**CARBATEC**  
Twin Featherboard Set  
Part No. **CT-FB-2PCE**



**HEDGEHOG**  
Spiral Featherboard  
Part No. **HH-100**  
Also available: Large Stacking Accessory  
Part No. **HH-30**



**KREG**  
Single Featherboard  
Part No. **KR-PRS3010**



**BOW PRODUCTS**  
FeatherPro Featherboard  
Part No. **BOW-FP1**



**BOW PRODUCTS**  
FeatherDuo  
Dual Featherboard Stack  
Part No. **BOW-FP3**



**BOW PRODUCTS**  
FencePro Featherboard  
Part No. **BOW-FP4**



**KREG**  
Twin Featherboards  
Part No. **KR-PRS3020**



**MAGSWITCH**  
Universal Featherboard  
Part No. **MAG-0015**



**ARCHER**  
Leather Shop Apron  
Part No. **AR-1783**



**CARBATEC**  
Canvas Apron  
Part No. **67K10-06**

# GLUES



**TITEBOND**  
Original Wood Glue, 3.8 Litre

Part No. **TBD-1-3785ML**  
Also available in 237 mL, 473 mL & 946 mL.



**TITEBOND**  
II Premium Wood Glue, 3.8 Litre

Part No. **TBD-2-3785ML**  
Also available in 237 mL, 473 mL & 946 mL.



**TITEBOND**  
III Ultimate Wood Glue, 3.8 Litre

Part No. **TBD-3-3785ML**  
Also available in 237 mL, 473 mL, & 946 mL.



**TITEBOND**  
Titebrush  
Part No. **TBD-TITEBRUSH**



**WEST SYSTEM**  
Gflex Epoxy Resin and Hardener,  
118 mL

Part No. **WES-650-8**



**VERITAS**  
Chair Doctor Glue, 2 Oz

Part No. **05K99-01**



**U-BEAUT**  
Hide Glue - 400 g (Granulated)

Part No. **UB-HG400**



**PREP**  
Multi-Use Adhesive, 500 mL  
Part No. **PREP-MULTI-500**



**ZAP**  
ZAP CA, Thin Viscosity, 2 oz,  
Cyanoacrylate 'Super' Glue

Part No. **ZAP-THIN**



**ZAP**  
ZAP-A-GAP, Medium Viscosity,  
2 oz, Cyanoacrylate 'Super' Glue

Part No. **ZAP-MEDIUM**



**ZAP**  
SLO-ZAP, Thick Viscosity, 2 oz,  
Cyanoacrylate 'Super' Glue

Part No. **ZAP-THICK**



**ZAP**  
ZIP KICKER, CA Accelerator, 2 oz,  
Cyanoacrylate 'Super' Glue

Part No. **ZAP-ACCEL**



**CARBATEC**  
Gluing Kit

Part No. **GB-55**



**ROCKLER**  
Glue Applicator Set

Part No. **RK-57361**



**CARBATEC**  
Glue Bottle Set

Part No. **GS-114**



**ROCKLER**  
3-Piece Silicone Glue  
Application Kit

Part No. **RK-43662**





**ORGANOIL**  
Garden Furniture Oil - 1 Litre  
Part No. **ORG-GF-1LTR**



**ORGANOIL**  
Tung Oil - 1 Litre  
Part No. **ORG-TUNG-1LTR**



**ORGANOIL**  
Danish Oil - 1 Litre  
Part No. **ORG-DO-1LTR**



**ORGANOIL**  
Hard Burnishing Oil - 500 mL  
Part No. **ORG-HB-500ML**



**ORGANOIL**  
Beeswax Polish - 200 g  
Part No. **ORG-BW-200**



**U-BEAUT**  
Food Safe Mineral Oil  
Part No. **UB-FS**



**U-BEAUT**  
Shellawax Glow - 500 mL\*  
Part No. **UB-SWG**



**U-BEAUT**  
Sanding Sealer - 500 mL\*  
Part No. **UB-SS500**



**U-BEAUT**  
Polish Reviver - 200 mL\*  
Part No. **UB-POLREV**



**U-BEAUT**  
Shellawax Cream - 250 mL\*  
Part No. **UB-SWC**



**U-BEAUT**  
Tripoli Powder 400g  
Part No. **UB-ROT**



**U-BEAUT**  
Water Dyes (7 x 50 mL) Non-Toxic  
Part No. **UB-WD7PK**



**U-BEAUT**  
EEE Ultra Shine  
Part No. **UB-EEE**



**KUSTOM CREATIONS**  
Kustom Rotary Polish  
Step 1 and Step 2 Set  
Part No. **KM-ROT-SET**



**KUSTOM CREATIONS**  
Kustom Wax Beeswax  
Paste and Liquid Set  
Part No. **KM-BEESWAX-SET**



**KUSTOM CREATIONS**  
Kustom High Speed Polish  
Step 1 and 2 Small Kit  
Part No. **KM-HSP-SK**

\*Dangerous Goods. Additional charges and restrictions apply to shipping.

**carbatec**

## New high torque clock movements and hands now available



**CARBATEC**  
High Torque C battery Clock  
Movement - 22.2 mm (7/8") shaft  
Part No. **MVT312HT**



**CARBATEC**  
Continuous Sweeping  
Clock Movement  
14 mm Shaft  
Part No. **CLK-CS14**  
Also available in:  
11 mm: Part No. **CLK-CS11**  
7 mm: Part No. **CLK-CS7**



**CARBATEC**  
Tide Movement 8 mm (5/16")  
Threaded Shaft Length  
Part No. **TIDE-MVT7160T**



**CARBATEC**  
Time and Tide Clock Movement  
Part No. **TIDE-MVTTNT09**



**CARBATEC**  
Tower Clock - Roman Style - Complete Kit Set  
Part No. **GNTCLKR**



**CARBATEC**  
Clock Movement  
24 mm Shaft  
Part No. **CLK-7290**  
Also available in:  
17 mm: Part No. **CLK-7260**  
11 mm: Part No. **CLK-7190**  
8 mm: Part No. **CLK-7160**

*To see the full range of clock hands and numbers available for all our clock movements, please visit our website.*



*A sample of our new, large, high torque clock hands*



**CARBATEC**  
Chrome Cigar Pen Kit -  
Pack of 1  
Part No. **PEN-CGCH**



**CARBATEC**  
Gold Euro Style Pen Kit  
(Single)  
Part No. **BT-401G**



**CARBATEC**  
Antique Pewter Rifle Bolt  
Pen Kit - Pack of 1  
Part No. **PEN-8040**



**CARBATEC**  
Gold & Chrome Sierra  
Twist Pen Kit - Pack of 1  
Part No. **PEN-SIEGCH**



**CARBATEC**  
Gold Ball Point Pen Kit -  
Twist Black Clip - Pack of 5  
Part No. **PEN-1**



**CARBATEC**  
Gunmetal Fancy Slimline  
Pen Kit - Pack of 1  
Part No. **PEN-7GM**

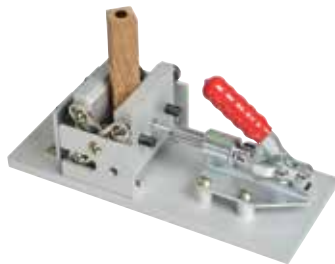

**CARBATEC**  
Quick Action Self-Centring  
Pen Blank Drilling Jig  
Part No. **CT-PV4**



*A comprehensive range of pen parts and pen blanks are available. Please contact us or visit our website for more information.*

**CARBATEC**  
Deluxe Pen Assembly Press  
Part No. **CT-PAP3**



**CARBATEC**  
Long Series Brad Point Bit  
7 mm - HSS

Part No. **BPD-8MM-PRC**  
Also available in 8 mm, 10 mm, 3/8"  
and 27/64"



**CARBATEC**  
Pen Mill Set with 3/4"  
Cutter (4 Edges) + 4 Shafts  
Part No. **CT-PM-SET-4E**



**CARBATEC**  
Synthetic Bushings  
Part No. **CT-SBUSH**



**CARBATEC**  
Pen Mandrel #2 MT  
Part No. **MAND-92**



**CARBATEC**  
Mixed Sanding Pads  
- 10.5 cm x 8 cm  
Part No.  
**SP-MMESH-SET-L**



**CARBATEC**  
Lazy Susan Bearings

Available in several sizes:  
L-33: 3" L-88: 8"  
L-44: 4" L-99: 9"  
L-66: 6" L-120: 12"



**CARBATEC**  
Stainless Steel BBQ  
Spatula and Fork Kit

Part No. **CT-BBQ-SET**  
Also available separately:  
CT-BBQF-SS and CT-BBQS-SS.



**CARBATEC**  
Stainless Steel Cheese  
Knife Kit 78 mm

Part No. **CT-CK78-SS**



**CARBATEC**  
Stainless Steel Garlic  
Press Kit

Part No. **CT-GP-SS**



**CARBATEC**  
Inset Bottle Opener -  
Stainless Steel

Part No. **CT-IBO-SS**



**CARBATEC**  
Stainless Steel Ice Cream  
Scoop Kit

Part No. **CT-ICS-SS**



**CARBATEC**  
Premium Stainless Steel  
Pizza Cutter Kit - 10 cm

Part No. **CT-PPC10-SS**



**CARBATEC**  
Gold Bottle Opener  
Key Chain

Part No. **CT-BOKC**



**CARBATEC**  
Chrome Crochet Hook  
Kit Set

Part No. **CT-CROCH-CH**



**CARBATEC**  
Gold Mini Scissors Kit

Part No. **CT-MS-G**



**CARBATEC**  
Gold Mini Tweezer Kit

Part No. **CT-MT-G**



**CARBATEC**  
Chrome Needle Threader  
Kit Set

Part No. **CT-NT-CH**



**CARBATEC**  
Colourful Vacuum Seam  
Ripper Kit

Part No. **CT-SR-CV**  
Also available in Gold CT-SR-G



**CARBATEC**  
Back Scratcher Kit - Gold

Part No. **CT-BS-G**



**CARBATEC**  
Diamond Knife Sharpener  
Kit

Part No. **CT-DKS**



**CARBATEC**  
Chrome Magnetic Pickup  
Tool Kit

Part No. **CT-MPUT**



**CARBATEC**  
Chrome Precision Cutting  
Knife Kit

Part No. **CT-PC-C**



**CARBATEC**  
Scratch Awl Kit - Gold

Part No. **CT-SA-G**



**EYE CANDY**  
Hue Series Box Set  
Part No.  
**ECC-02003**



**EYE CANDY**  
Colour Shift Box Set  
Part No.  
**ECC-02023**



**EYE CANDY**  
Neon Series Box Set  
Part No.  
**ECC-02025**



**EYE CANDY**  
River Ocean Box Set  
Part No.  
**ECC-08001-05**



**EYE CANDY**  
Glow in the Dark Box Set  
Part No.  
**ECC-02027-05**

A comprehensive range of individual coloured pigments is also available. Please contact us or visit our website for more information.



**KUSTOM CREATIONS**  
Kustom Grit Superfine and Microfine Grit  
Step 1 and Step 2 Set  
Part No. **KM-GRIT-SET**



**WEST SYSTEM**  
Epoxy Resin 105\*  
Part No. **WES-105R**  
Available in 1 litre & 4 litre

\* Epoxy Resin and Epoxy Hardeners are Dangerous Goods. NZ Post Couriers have declined to carry Epoxy Hardener as it is corrosive. We can send by ChemCouriers but costs are very high. We apologise for the inconvenience this causes but Carbatec comply with the Land Transport Rule and New Zealand Standards. These products are available for instore purchasing and Click & Collect in both our Auckland and Christchurch stores.



**WEST SYSTEM**  
Hardener 205\*, 206\* & 207\*  
Part No. **WES-FH**  
Part No. **WES-SH**  
Part No. **WES-H**  
Available in 200 mL, 333 mL, 800 mL, 1.33 litre



*Robert Sorby*

**ROBERT SORBY  
Peter Child Artist's  
Pyrography Machine**

Part No. **RSB-PYR02400**



**FLEXCUT  
KN50 Sloyd Knife**

Part No. **FLX-KN-50**



**FLEXCUT  
Flexible Drawknife**

Part No. **FLX-KN-16**



**FLEXCUT  
3 Knife Starter Set**

Part No. **FLX-KN-500**



**FLEXCUT  
KN52 Single Bevel  
Sloyd Hook Knife**

Part No. **FLX-KN-52**



**FLEXCUT  
6 Piece Mallet Starter Set**

Part No. **FLX-MC-150**



**FLEXCUT  
Beginner Palm & Knife Set**

Part No. **FLX-KN-600**

A comprehensive range of individual woodcarving chisels is available.  
Please contact us or visit our website for more information.



**FLEXCUT  
Knife Strop**

Part No. **FLX-PW-14**



**FLEXCUT  
Gold Compound**

Part No. **FLX-PW-11**



**FLEXCUT  
Slipstrop Kit**

Part No. **FLX-PW-12**



**FLEXCUT  
Carving Knife Set**

Part No. **FLX-KN-100**





**FLEXCUT**  
Spoon Carvin' Jack 2.0  
Part No. **FLX-JKN-296**



**FLEXCUT**  
Right-Handed Carvin' Jack 2.0  
Part No. **FLX-JKN-291**  
Also available for Left-Handers:  
FLX-JKN-291L



**CARBATEC**  
Bench Mounted Carvers Stand  
Part No. **CV-01**



**PFEIL**  
Chisel 13-14  
Part No. **PF-13-14**  
Straight shanked 90° V-tool,  
14 mm wide



**PFEIL**  
Lino Chisel Set - 12 Piece  
Part No. **PF-PALM-12**



**PFEIL**  
Chisel Roll Set - 12 piece  
Part No. **PF-RLSET-12**



**FLEXCUT**  
Regular Palm Set 5 piece Wood Box  
Part No. **FLX-FR-310**



**FLEXCUT**  
Mini Palm Set  
Part No. **FLX-FR-604**



**FLEXCUT**  
Micro Palm Set  
Part No. **FLX-FR-804**



**ARBORTECH**

**ARBORTECH  
MIN 900 Complete Mini Carver Unit**  
Part No. **ARB-MIN-900**



**ARBORTECH**

**ARBORTECH  
Power Chisel - New 900 series with a  
Set of 7 Chisels**  
Part No. **ARB-PCH-900**



**ARBORTECH**

**ARBORTECH  
Power Carving Unit 900 series**  
Part No. **ARB-PWC-900**



**ARBORTECH**

**ARBORTECH  
Turbo Plane**  
Part No. **ARB-IND400**



**ARBORTECH**

**ARBORTECH  
Industrial Pro Kit**  
Part No. **ARB-IND200**



**ARBORTECH**

**ARBORTECH  
Ball Gouge**  
Part No. **ARB-BAL-2000**



**KUTZALL**

**KUTZALL  
Dish Wheel Fine**  
Part No. **KUTZ-DW4120230**  
Also available in Coarse, Very Coarse and  
VC/M/C Extreme



**KUTZALL**

**KUTZALL  
Sanding Disc Fine**  
Part No. **KUTZ-SD4120230**  
Also available in Coarse, Very Coarse,  
VC/M/C Extreme



**KUTZALL**

**KUTZALL  
Variety Kit for 1/8" Grinders  
- 5 Piece**  
Part No. **KUTZ-18VKIT01**  
Also available in Coarse & Very  
Coarse Kits



**KUTZALL**

**KUTZALL  
Variety Kit for 1/4" Grinders  
- 4 Piece**  
Part No. **KUTZ-14VKIT01**  
Also available in Very Coarse Kit  
FLX-JKN-291L

**NEW!**

# RAMIA<sup>®</sup> WORKBENCH

Ramia workbenches beat building your own! They are faster, cost-effective, and come in a variety of options. Made with solid Birch wood, they are easy to assemble and boast beautiful finishes. Find them at Carbatec along with cabinets and accessories.



## RM-SCH-X

This 1200 mm square worktop is great for introducing students to woodworking. The timber-jawed, metal woodworking vices are robust enough for new woodworkers but won't damage their work. Sturdy timber legs provide a stable base for this workbench. Optional adjustable steel legs and locking storage cupboards are also available.



**NEW!**

# RAMIA<sup>®</sup> WORKBENCH

## RAMIA Quad Teaching Workbench - SCHOOL Series

Part No. **RM-SCH-X**

- 4 vices (190 mm capacity)
- 40 mm thick worktop
- Pre-drilled bench dog holes for each vice
- Shared tool well in the centre
- 8 round bench dogs included

**NEW!**

# RAMIA<sup>®</sup> WORKBENCH

## RAMIA Premium Monster 1700 Workbench - PRO Series

Part No. **RM-PRO-ASM1700**

- Front vice: 190 mm capacity
- Tail vice: 145 mm capacity
- 50 mm thick worktop with pre-drilled bench dog holes
- Tool well at rear of worktop
- Storage drawer
- Shared tool well in the centre
- 4 PRO Series round bench dogs included



## RM-PRO-ASM1700

Designed for the exacting woodworker, this premium workbench features two traditional vices (front and tail) and a 50 mm worktop. Weighing in at 90kg, this bench provides a stable platform for your most demanding projects.

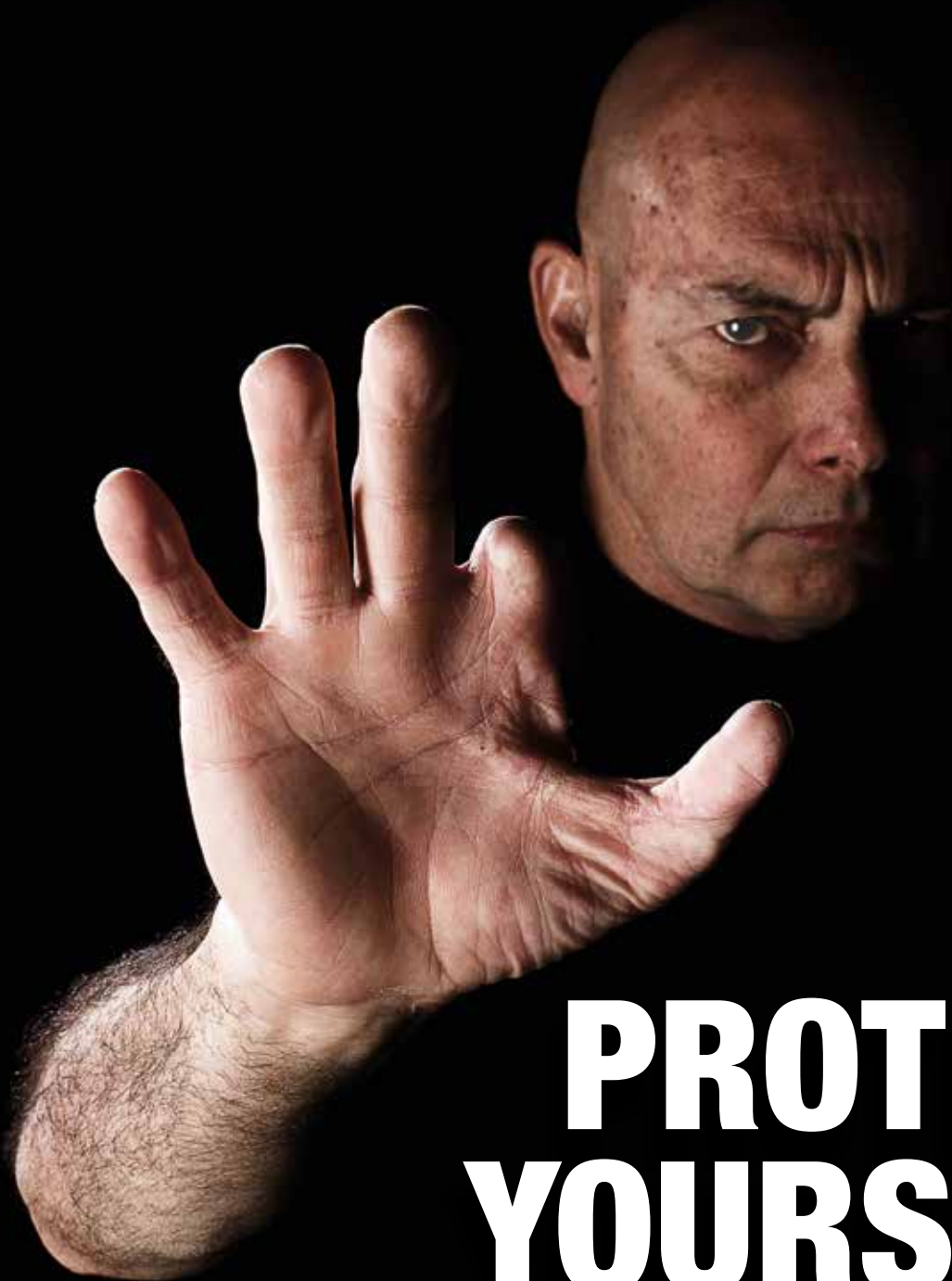

# PROTECT YOURSELF



THE WORLD'S SAFEST TABLE SAW

## THE TABLE SAW IS THE MOST DANGEROUS TOOL IN YOUR SHED.

SawStop table saws stop on contact with skin. With 15 years of industry-leading quality and thousands of fingers saved, it's easy to see why SawStop is the #1 cabinet saw across North America

Visit our knowledgeable team in store or call 0800 444 329

**CARBATEC.CO.NZ**

**carbatec**  
THE HOME OF WOODWORKING

**AUCKLAND**  
110 HARRIS RD  
EAST TAMAKI  
AKL 2013

**CHRISTCHURCH**  
67 STURROCKS RD  
CASEBROOK  
CHC 8051

**ADELAIDE**  
27 MAGILL RD  
STEPNEY  
SA 5069

**BRISBANE**  
128 INGLESTON RD  
WAKERLEY  
QLD 4154

**HOBART**  
17 FARLEY ST  
GLENORCHY  
TAS 7010

**MELBOURNE**  
80-82 OSBORNE AVE  
SPRINGVALE  
VIC 3171

**PERTH**  
1/168 BALCATT A RD  
BALCATT A  
WA 6021

**SYDNEY**  
113 STATION RD  
AUBURN  
NSW 2144

While every effort has been made to ensure the information contained in this catalogue is accurate, we cannot guarantee it is free of mistakes or errors and we recommend you refer to our website for more information.